

DC AXIAL FAN 30x30x10mm



Housing/Blade: Thermoplastic PBT, UL 94V-0
 Insulation Resistance: 10MΩ, 500VDC/min between bare wire and frame
 Dielectric Strength: 5mA max. 500VAC/min between bare wire and frame
 Operation Temperature: -10°C~70°C(Humidity 35%-85%RH)
 Storage Temperature: -40°C~70°C(Humidity 35%-85%RH)
 Lead Wire: UL Type #28 AWG
 Weight: 7 g Packing: 600PCS/CTN



SS

SF



DC Axial Fans

Model Number	Voltage (VDC)	Op. Voltage (VDC)	Air Flow (CFM)	Static Pres. (mm-H ₂ O)	Noise (dBA)	Speed (RPM)	Current (mA)	Power (W)	Available Bearing	Curves
FD3010B05W3-71	5	4.0~5.5	2.50	2.60	19.00	5,500	100	0.50	B,L,S	①
FD3010B05W7-71	5	4.0~5.5	3.60	3.80	22.90	8,000	180	0.90	B,L,S	②
FD3010B05W9-71	5	4.0~5.5	4.30	4.50	28.00	9,500	200	1.00	B,L,S	③
FD3010B12W3-71	12	10.8~13.2	2.50	2.60	19.00	5,500	60	0.72	B,L,S	①
FD3010B12W7-71	12	10.8~13.2	3.60	3.80	22.90	8,000	110	1.32	B,L,S	②
FD3010B12W9-71	12	10.8~13.2	4.30	4.50	28.00	9,500	120	1.44	B,L,S	③

• For "Long Life", or "Sleeve" bearing versions, change the "B" in the model number to "L", or "S" respectively.

Specifications are subject to change without notice

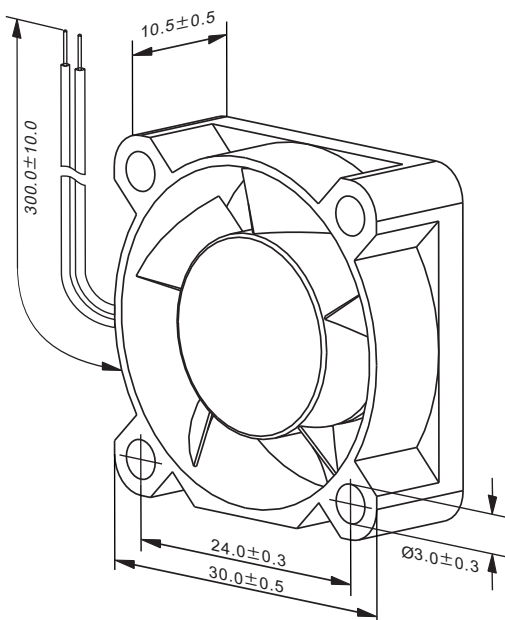

unit: mm

