

TOS-20101AMR-B

Single Digit Display LED

Part Number	Chip		Face Color	Segment Color
	Material	Source Color		
TOS-20101AMR-B	AlGaInP	Ultra-red	Black	White

Features

- (2.00") 50.80mm digit height
- Common cathode
- I.C. compatible
- Low power requirement
- RoHS compliant

Applications

- Audio equipment
- Instrument panels
- Digital read out display

Package Dimensions & Internal Circuit Diagram

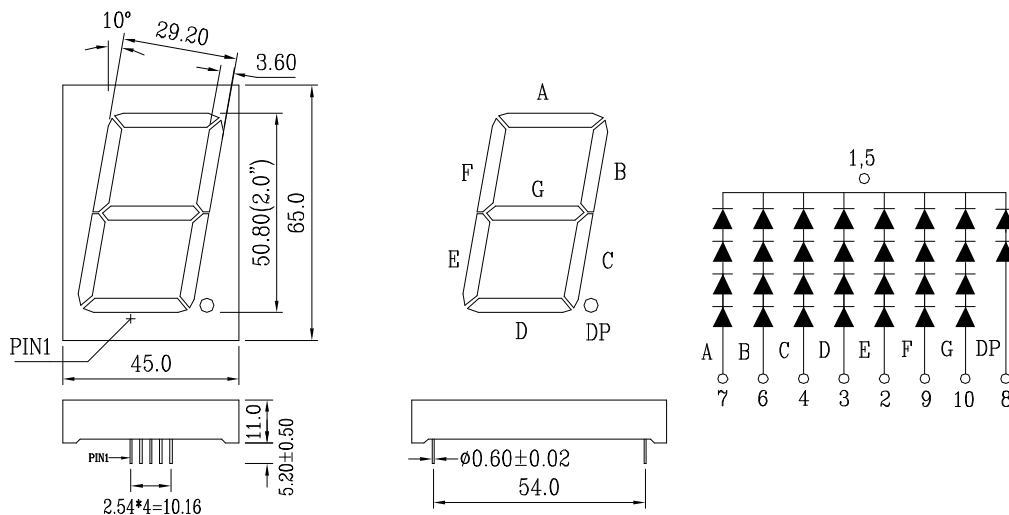

Notes:

1. All dimensions are in millimeters, tolerance: ± 0.25 ; Angle: $\pm 0.1^\circ$ unless otherwise noted.
2. Specifications are subject to change without notice.

Absolute Maximum Rating @ Ta=25°C

Parameter	Maximum Rating	Unit
Peak Forward Current (1/10 Duty Cycle, 0.1ms Pulse Width)	80	mA
Power Dissipation Per Dice	75	mW
Continuous Forward Current	20	mA
Recommend Operating Current	12	mA
Reverse Voltage Per Dice	5	V
Operating Temperature Range	-25°C to +85°C	
Storage Temperature Range	-30°C to +85°C	
Lead-Free Solder Temperature (1/16 Inch Below Seating Plane)	260°C for 3 Sec	

Electrical / Optical Characteristic @ Ta=25°C

Parameter	Symbol	Min.	Typ.	Max.	Unit	Test Condition	Grade
Luminous Intensity	I _v		21937		ucd	I _F =10mA	
Donminant Wavelength	λ _d		630		nm	I _F =20mA	
Spectral Line Half-Width	Δλ		15		nm	I _F =20mA	
Forward Voltage Per Dice	V _F	1.8	2.0	2.3	V	I _F =20mA	
Reverse Current Per Dice	I _R			100	μA	V _R =5V	
Luminous Intensity Matching Rate	I _v -m			2.0:1		I _F =20mA	